

Yealink



<http://support.yealink.com/>

SIP-T30 & T30P Classic IP Phone

Quick Start Guide

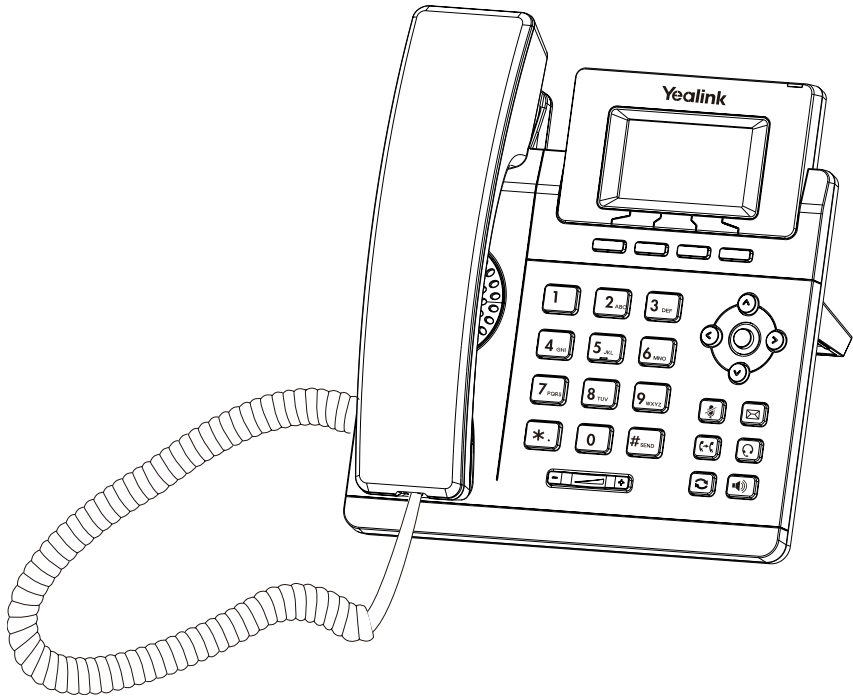

Applies to firmware version 124.85.0.1 or later.

Package Contents

The following items are included in your package. If you find anything missing, contact your system administrator.

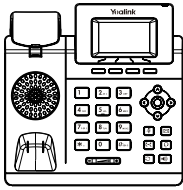

IP Phone



Handset

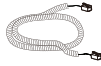

Handset Cord



Ethernet Cable



Stand



Quick Start Guide

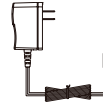

Power Adapter
(T30P: Optional)

 We recommend that you use the accessories provided or approved by Yealink. The unapproved third-party accessories may result in reduced performance.

Assembling the Phone

1. Attach the stand:

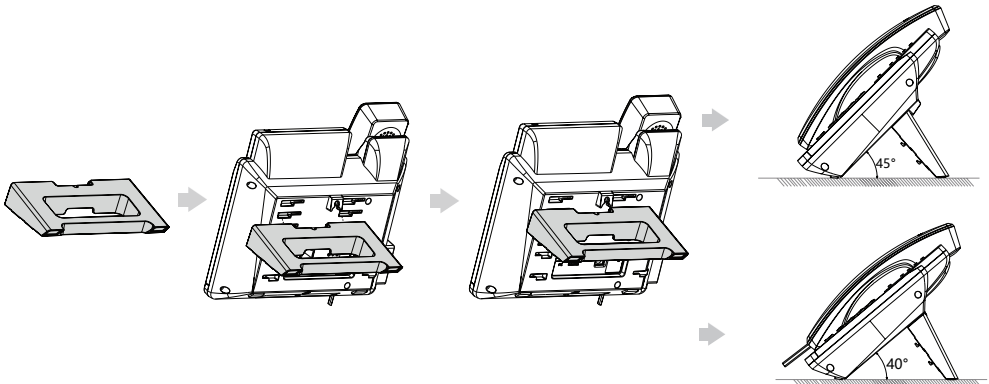

 You can also mount the phone to a wall.

2. Connect the handset and optional headset:

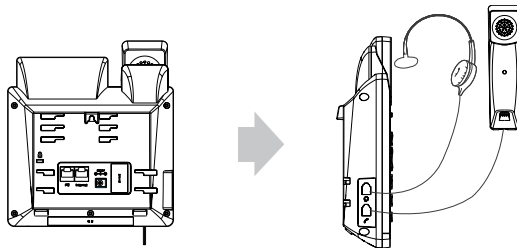

3. Connect the network and power:

You have two options for network and power connections. Your system administrator will advise you which one to use.

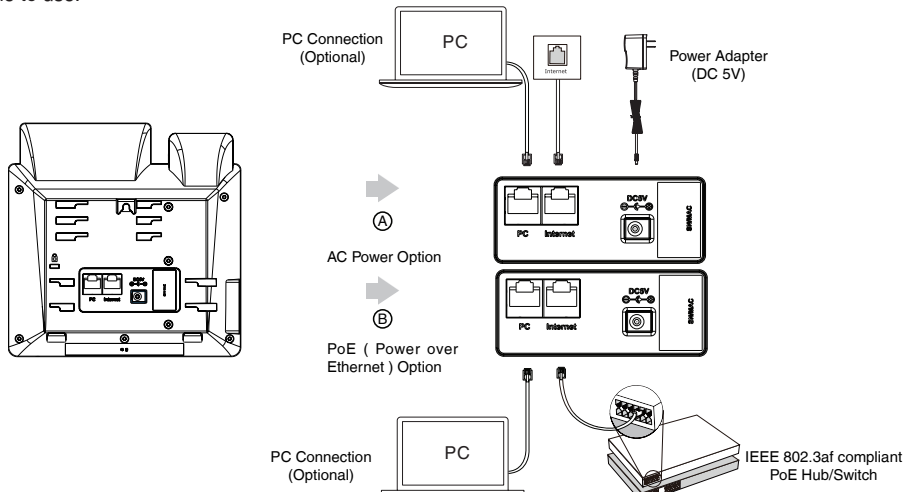

 The IP phone should be used with Yealink original power adapter (5V/600mA) only. The use of the third-party power adapter may cause the damage to the phone. If you are connecting a PC to your phone, we recommend that you use the Ethernet cable provided by Yealink.
If inline power (PoE) is provided, you don't need to connect the power adapter. Make sure the hub/switch is PoE-compliant. PoE is only applicable to the SIP-T30P IP phone.

Startup

After the IP phone is connected to the network and supplied with power, it automatically begins the initialization process. After startup, the phone is ready for use. You can configure the phone via phone user interface or web user interface.

Welcome
Initializing... Please wait

Configuring Your Phone

Configuring via web user interface

Accessing the web user interface:

1. Press  (the **OK** key) when the phone is idle to obtain the IP address of the phone.
2. Open a web browser on your computer, enter the IP address into the address bar (e.g., "http://192.168.0.10" or "192.168.0.10") and then press the **Enter**.
3. Enter the user name (default: admin) and password (default: admin) in the login page and click **Login**.

Network Settings: Click on **Network->Basic->IPv4 Config**

You can configure the network settings in the following ways:

DHCP: By default, the phone attempts to contact a DHCP server in your network to obtain its valid network settings, e.g., IP address, subnet mask, gateway address and DNS address.

Static IP Address: If your phone cannot contact a DHCP server for any reason, you need to configure the IP address, subnet mask, gateway address, primary DNS address and secondary DNS address for the phone manually.

 The IP phone also supports IPv6, but IPv6 is disabled by default.

Wrong network settings may result in the inaccessibility of your phone and may have an impact on the network performance. Contact your system administrator for more information.

Account Settings: Click on **Account->Register**

Parameters of the account:

Register Status:	It shows the register status of the current account.
Line Active:	You can select Enabled/Disabled to enable/disable the account.
Label:	It is shown on the LCD screen to identify the account.
Display Name:	It is shown as caller ID when placing a call.
User Name:	It is provided by ITSP for registration (required).
Register Name:	It is an authenticated ID for authentication provided by ITSP (required).
Password:	It is provided by ITSP for registration (required).
Server Host:	It is provided by ITSP for registration (required).

Register status icons on the LCD screen:



Registered



Registering



Register Failed

 Check with your system administrator if any error appears during the registration process or a specific configuration is required for your registration.

Configuring via phone user interface

Network Settings:

Press the **Menu** soft key when the phone is idle, select **Settings->Advanced Settings** (default password: admin)->**Network->WAN Port->IPv4** to configure the network.

Account Settings:

Press the **Menu** soft key when the phone is idle, select **Settings->Advanced Settings** (default password: admin)->**Accounts** to configure the account.

 For more information on account parameters, refer to **Configuring via web user interface** above.

Placing a Call

Using the handset:

1. Pick up the handset.
2. Enter the number and press the **Send** soft key.

Using the speakerphone:

1. With the handset on-hook, press .
2. Enter the number and press the **Send** soft key.

Using the headset:

1. With the headset connected, press  to activate the headset mode.
2. Enter the number and press the **Send** soft key.

Answering a Call

Using the handset:

Pick up the handset.

Using the speakerphone:

Press .

Using the headset:

Press .

 You can reject an incoming call by pressing the **Reject** soft key.

Ending a Call

Using the handset:

Hang up the handset or press the **EndCall** soft key.

Using the speakerphone:

Press  or the **EndCall** soft key.



Using the headset:

Press the **EndCall** soft key.

Redial

- Press  to enter the **Placed Calls** list, select the desired entry, and press  or the **Send** soft key.
- Press  twice when the phone is idle to dial out the last dialed number.

Call Mute

- Press  to mute the microphone during a call.
- Press  again to un-mute the call.

Call Hold

To place a call on hold:

Press the **Hold** soft key during an active call.



To resume the call, do one of the following:

- If there is only one call on hold, press the **Resume** soft key.
- If there is more than one call on hold, select the desired call, and press the **Resume** soft key.

Call Transfer

You can transfer a call in the following ways:

Blind Transfer

1. Press  or the **Trans** soft key during a call.
2. Enter the number you want to transfer to.
3. Press  or the **B Trans** soft key.

Semi-Attended Transfer

1. Press  or the **Trans** soft key during a call.
2. Enter the number you want to transfer to, and press the **Send** soft key.
3. Press  or the **Trans** soft key when you hear the ring-back tone.

Attended Transfer

1. Press  or the **Trans** soft key during a call.
2. Enter the number you want to transfer to, and press the **Send** soft key.
3. Press  or the **Trans** soft key when the second party answers.

Call Forward

To enable call forward:

1. Press the **Menu** soft key when the phone is idle, and then select **Features->Call Forward**.
2. Select the desired forward type.
3. Enter the number you want to forward to. For **No Answer Forward**, select the desired ring time to wait before forwarding from the **After Ring Time** field.
4. Press the **Save** soft key to accept the change.

Call Conference

1. Press the **Conf** soft key during an active call. The call is placed on hold.
2. Enter the number of the second party, and press the **Send** soft key.
3. Press the **Conf** soft key again when the second party answers. All parties are now joined in the conference.
4. Press the **EndCall** soft key to disconnect all parties.

 You can split the conference call into two individual calls by pressing the **Split** soft key.



Voice Message

Message waiting indicator on the idle screen indicates that one or more voice messages are waiting at the message center. The power indicator LED slowly flashes red.

To listen to voice messages:

1. Press  or the **Connect** soft key.
2. Follow the voice prompts to listen to your voice messages.

Call History

1. Press the **History** soft key when the phone is idle, press  or  to scroll through the list.
2. Select an entry from the list, you can do the following:
 - Press the **Send** soft key to call the entry.
 - Press the **Delete** soft key to delete the entry from the list.

If you press the **Option** soft key, you can also do the following:



- Select **Detail** to view detailed information about the entry.
- Select **Add to Contacts** to add the entry to the local directory.
- Select **Add to Blacklist** to add the entry to the blacklist.
- Select **Delete All** to delete all entries from the list.

Contact Directory



To add a contact:

1. Press the **Dir** soft key when the phone is idle, and then select **All Contacts**.
2. Press the **Add** soft key to add a contact.
3. Enter a unique contact name in the **Name** field and contact numbers in the corresponding fields.
4. Press the **Save** soft key to accept the change.

To edit a contact:

1. Press the **Dir** soft key when the phone is idle, and then select **All Contacts**.
2. Press  or  to select the desired contact, press the **Option** soft key and then select **Detail** from the prompt list.
3. Edit the contact information.
4. Press the **Save** soft key to accept the change.

To delete a contact:

1. Press the **Dir** soft key when the phone is idle, and then select **All Contacts**.
2. Press  or  to select the desired contact, press the **Option** soft key and then select **Delete** from the prompt list.
3. Press the **OK** soft key when the LCD screen prompts "Delete selected item?".

Volume Adjustment

Press  to adjust the volume.

Regulatory Notices

Operating Ambient Temperatures

- Operating temperature: +14 to 122°F (-10 to 50°C)
- Relative humidity: 5% to 90%, noncondensing
- Storage temperature: -22 to +160°F (-30 to +70°C)

Warranty

Our product warranty is limited only to the unit itself, when used normally in accordance with the operating instructions and the system environment. We are not liable for damage or loss resulting from the use of this product, or for any claim from a third party. We are not liable for problems with Yealink device arising from the use of this product; we are not liable for financial damages, lost profits, claims from third parties, etc., arising from the use of this product.

Explanation of the symbols

- DC symbol

— is the DC voltage symbol.

- WEEE Warning symbol

 To avoid the potential effects on the environment and human health as a result of the presence of hazardous substances in electrical and electronic equipment, end users of electrical and electronic equipment should understand the meaning of the crossed-out wheeled bin symbol. Do not dispose of WEEE as unsorted municipal waste and have to collect such WEEE separately.

Restriction of Hazardous Substances Directive (RoHS)

This device complies with the requirements of the EU RoHS Directive. Statements of compliance can be obtained by contacting support@yealink.com.

Safety Instructions

Save these instructions. Read these safety instructions before use!

General Requirements

- Before you install and use the device, read the safety instructions carefully and observe the situation during operation.
- During the process of storage, transportation, and operation, please always keep the device dry and clean, avoid collision and crash.
- Please attempt not to dismantle the device by yourself. In case of any discrepancy, please contact the appointed maintenance center for repair.
- Please refer to the relevant laws and statutes while using the device. Legal rights of others should be respected as well.

Environmental Requirements

- Place the device at a well-ventilated place. Do not expose the device under direct sunlight.
- Keep the device dry and free of dusts.
- Do not place the device on or near any inflammable or fire-vulnerable object, such as rubber-made materials.
- Keep the device away from any heat source or bare fire, such as a candle or an electric heater.

Operating Requirements

- Do not let a child operate the device without guidance.
- Do not let a child play with the device or any accessory in case of accidental swallowing.
- Please use the accessories provided or authorized by the manufacturer only.
- The power supply of the device shall meet the requirements of the input voltage of the device. Please use the provided surge protection power socket only.
- Before plugging or unplugging any cable, make sure that your hands are completely dry.
- Do not spill liquid of any kind on the product or use the equipment near water, for example, near a bathtub, washbowl, kitchen sink, wet basement or near a swimming pool.
- During a thunderstorm, stop using the device and disconnect it from the power supply. Unplug the power plug and the Asymmetric Digital Subscriber Line (ADSL) twisted pair (the radio frequency cable) to avoid

lightning strike.

- If the device is left unused for a rather long time, disconnect it from the power supply and unplug the power plug.
- When there is smoke emitted from the device, or some abnormal noise or smell, disconnect the device from the power supply, and unplug the power plug immediately.
- Contact the specified maintenance center for repair.
- Do not insert any object into equipment slots that is not part of the product or auxiliary product.
- Before connecting a cable, connect the grounding cable of the device first. Do not disconnect the grounding cable until you disconnect all other cables.

Cleaning Requirements

- Before cleaning the device, disconnect it from the power supply.
- Use a piece of soft, dry and anti-static cloth to clean the device.
- Keep the power plug clean and dry.

Troubleshooting

The unit cannot supply power to Yealink device.

There is a bad connection with the plug.

1. Clean the plug with a dry cloth.
 2. Connect it to another wall outlet.
- The usage environment is out of operating temperature range.

1. Use in the operating temperature range.

The cable between the unit and the Yealink device is connected incorrectly.

1. Connect the cable correctly. You cannot connect the cable properly.
1. You may have connected a wrong Yealink device.
2. Use the correct power supply. Some dust, etc., may be in the port.

1. Clean the port.

Contact your dealer or authorized service facility for any further questions.

FCC Statement

This device complies with part 15 of the FCC Rules. Operation is subject to the following two conditions: (1) this device may not cause harmful interference, and (2) this device must accept any interference received, including interference that may cause undesired operation.

Any Changes or modifications not expressly approved by the party responsible for compliance could void the user's authority to operate the equipment.

IC Statement

1. This device complies with Industry Canada's licence-exempt RSSs. Operation is subject to the following two conditions:

- (1) this device may not cause interference; and
- (2) this device must accept any interference, including interference that may cause undesired operation of the device. CAN ICES-3(B)

Le présent appareil est conforme aux CNR d'Industrie Canada applicables aux appareils radio exempts de licence. L'exploitation est autorisée aux deux conditions suivantes :

- (1) l'appareil ne doit pas produire de brouillage;
- (2) l'utilisateur de l'appareil doit accepter tout brouillage radioélectrique subi, même si le brouillage est susceptible d'en compromettre le fonctionnement. NMB-3(B)

2. This device meets CS03 Part V.

"This device meets the applicable Innovation, Science and Economic Development Canada technical specifications. / Ce produit répond à la innovation, des sciences et de Développement économique Canada spécifications techniques applicables."

Contact Information

YEALINK NETWORK TECHNOLOGY CO.,LTD.

309, 3rd Floor, No.16, Yun Ding North Road, Huli District, Xiamen City, Fujian, P.R.C

YEALINK (EUROPE) NETWORK TECHNOLOGY B.V.

Strawinskylaan 3127, Atrium Building, 8th floor, 1077ZX Amsterdam, The Netherlands

YEALINK (USA) NETWORK TECHNOLOGY CO., LTD.

999 Peachtree Street Suite 2300, Fulton, Atlanta, GA, 30309, USA

Made in China

About Yealink

Yealink is a global leading provider of enterprise communication and collaboration solutions, offering video conferencing service to worldwide enterprises. Focusing on research and development, Yealink also insists on innovation and creation. With the outstanding technical patents of cloud computing , audio, video and image processing technology, Yealink has built up a panoramic collaboration solution of audio and video conferencing by merging its cloud services with a series of endpoints products. As one of the best providers in more than 140 countries and regions including the US, the UK and Australia, Yealink ranks No.1 in the global market share of SIP phones shipments.

Technical Support

Visit Yealink WIKI (<http://support.yealink.com/>) for the latest firmware, guides, FAQ, Product documents, and more. For better service, we sincerely recommend you to use Yealink Ticketing system (<https://ticket.yelink.com>) to submit all your technical issues.

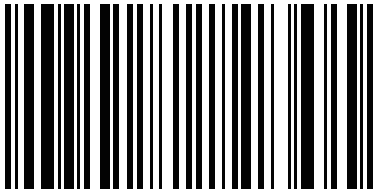

430104001361

YEALINK(XIAMEN) NETWORK TECHNOLOGY CO.,LTD.
Web: www.yealink.com
Copyright©2020 YEALINK(XIAMEN) NETWORK
TECHNOLOGY CO.,LTD.All rights reserved.